

## LED Light Fittings

### HRD85 Series Explosion-proof LED Lightings



- ◆ Explosion protection to
  - CENELEC
  - IEC
  - NEC
- ◆ Can be used in
  - Zone 1 and Zone 2
  - Zone 21 and Zone 22
  - Class I, Zone 1 and Zone 2
  - Class I, Division 1, Groups A, B, C, D
- ◆ Three enclosure types:30, 70, 120
- ◆ Applicable lamp and power (max.120W)  
LED : 20W, 30W, 50W, 70W, 100W, 120W
- ◆ Isolated LED lamp compartment, CC-CV (constant current - constant voltage) power controller compartment and terminal compartment; Wind-convection heat dissipation structure

#### Catalogue number logic

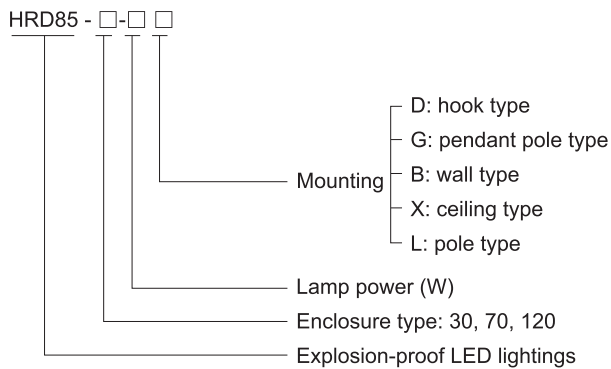

#### Selection table

Type / Ordering code	Lamp power(W)
HRD85-30-□ □	20, 30
HRD85-70-□ □	50, 70
HRD85-120-□ □	100, 120

**Note:** 1. Products above include all the mounting accessories listed in Mounting Accessories & Spare Parts Table (see P2/48~49).  
2. The product is supplied according to "Type/Ordering code" in the table with mounting accessories.

# Zones 1&2; 21&22

## LED Light Fittings

### HRD85 Series Explosion-proof LED Lightings

Technical data	
<b>Explosion-proof LED lightings HRD85-□-□□</b>	
<b>Explosion protection</b>	<p>Gas explosion protection <math>\text{Ex d IIC T6/T5 Gb}</math> Ex d IIC T6/T5 Gb</p> <p>Dust explosion protection <math>\text{Ex t IIIC T80°C/T95°C Db IP66}</math> Ex t IIIC T80°C/T95°C Db IP66</p>
<b>Certificates</b>	DNV 12 ATEX 10807X; IECEx CQM 12.0009X; KZ.7500525.22.01.00380 (CU-TR)
<b>Conformity to standards</b>	EN 60079-0, EN 60079-1, EN 60079-31 IEC 60079-0, IEC 60079-1, IEC 60079-31
<b>Material</b>	
Enclosure	Copper-free aluminium, powder coated surface, yellow (RAL1021)
Transparent cover	Toughened glass, stands 4J impact
Exposed fastener	Stainless steel
LED driver	Wide voltage input, CC-CV (constant current - constant voltage) output, power factor $\geq 0.95$ , with function of distributed current, constant current, surge-proof and anti-electromagnetic interference, and protection against overcurrent, open circuit, and short circuit
<b>Lamp</b>	
Lamp specification	International brand of LED module
Lamp power (W)	20W, 30W, 50W, 70W, 100W, 120W
Colour Temperature (CCT)	Cool white: 5400~6500K Note: cool white is available in general. Warm white (2700~3500K) or nature white (4700~5400K) is optional, please specify when ordering.
<b>Rated voltage</b>	187~265V AC 50/60Hz
<b>Earthing protection</b>	M5 (internal & external earth bolts)
<b>Degree of protection</b>	IP66, IP67(optional)
<b>Ambient temperature</b>	T5/T95°C for Tamb: -40°C~+55°C; T6/T80°C for Tamb: -40°C~+40°C
<b>Terminal</b>	3 x 1.5~4mm <sup>2</sup> (L+N+PE)
<b>Mounting</b>	Ceiling type, pole type, pendant pole type, wall type, hook type
<b>Cable entries</b>	30 type: G3/4" (NPT3/4" or M25 x 1.5 with connector on request) 70 /120 type: 1 x G3/4" (pendant pole type and hook type) 4 x M25x1.5 (wall type and ceiling type); 1 x G1" (pole type)
<b>Cable gland</b>	See Mounting Accessories & Spare Parts Table
<b>Available cable outer diameter</b>	$\Phi 10 \sim \Phi 14$ (mm)



### Dimension drawings (all dimensions in mm) - subject to alteration

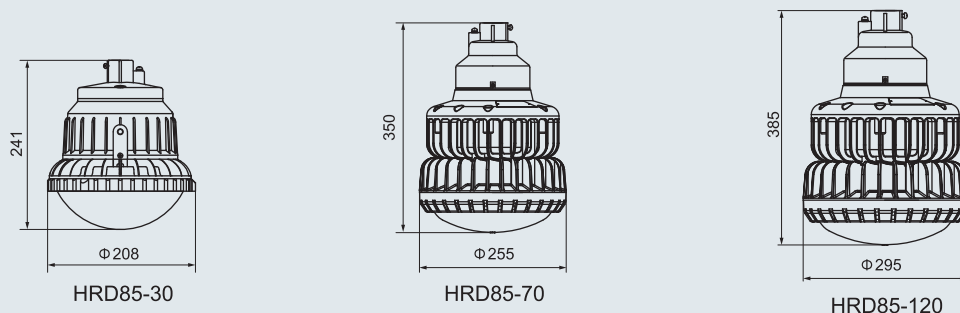

## LED Light Fittings HRD85 Series Explosion-proof LED Lightings

**Photometric data** Note: LED luminous flux is from the standard product of which colour temperature is 5400 to 6500K (cool white).



### HRD85-30-□□

Rated luminous flux  
20W LED: 1800lm  
30W LED: 2700lm

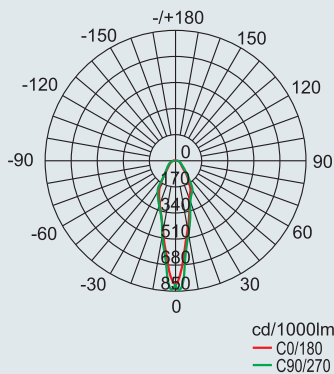

### HRD85-70-□□

Rated luminous flux  
50W LED: 4500lm  
70W LED: 6300lm

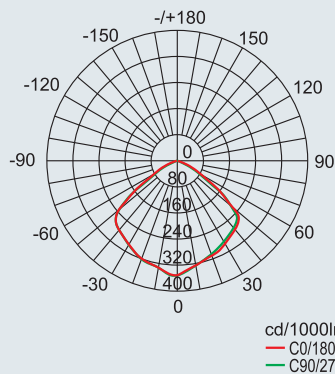

### HRD85-120-□□

Rated luminous flux  
100W LED: 9000lm  
120W LED: 10800lm

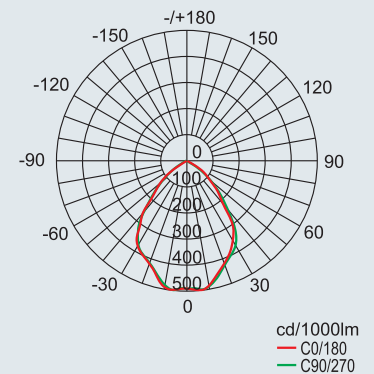

We can provide lighting design and data by professional lighting software DIALUX based upon simulated site situation on request.



### Mounting type (for HRD85-30 type) (all dimensions in mm)-subject to alteration

Installation reference

D: hook type

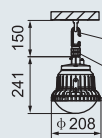

weight: 3.64kg

X: ceiling type

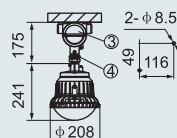

weight: 4.05kg

G: pendant pole type

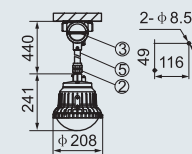

weight: 4.45kg

L: pole type

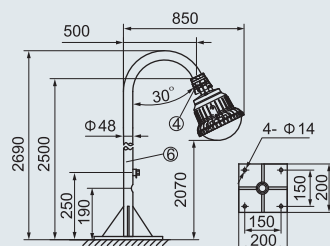

weight: 3.25kg (without pole ⑥)

B: wall type

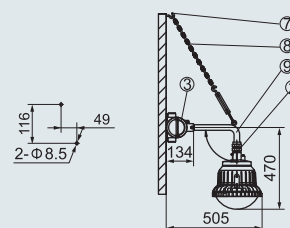

weight: 4.42kg

## LED Light Fittings HRD85 Series Explosion-proof LED Lightings

### Mounting Accessories & Spare Parts Table (for HRD85-30 type)

Supplied according to the mounting type

Mounting type	Accessories			Ordering code	Weight (kg)
	Name	Qty	Illustration		
D: hook type	① Hook (carbon steel)	1	See P2/79	61020	0.20
	② BGJ-III Explosion-proof connector	1	G3/4"(M)/M25 x 1.5(F) Carbon steel	81D02	0.26
X: ceiling type	③ BHD51 Explosion-proof junction box	1	Copper-free aluminium (Ex d IIC)	BHD51-F	0.80
	④ BGJ-III Explosion-proof connector	1	M25 x 1.5(M)/ G3/4"(M) Carbon steel	81X01	0.30
G: pendant pole type	② BGJ-III Explosion-proof connector	1	G3/4"(M)/M25 x 1.5(F) Carbon steel	81D02	0.26
	③ BHD51 Explosion-proof junction box	1	Copper-free aluminium (Ex d IIC)	BHD51-F	0.80
	⑤ Straight pipe (M25 x 1.5)	1	Length: 300mm	81G01	0.41
L: pole type	④ BGJ-III Explosion-proof connector	1	M25 x 1.5(M)/ G3/4"(M) Carbon steel	81X01	0.30
	⑥ Pole	1	Φ48mm	81L01	-
B: wall type	② BGJ-III Explosion-proof connector	1	G3/4"(M)/M25 x 1.5(F) Carbon steel	81D02	0.26
	③ BHD51 Explosion-proof junction box	1	Copper-free aluminium (Ex d IIC)	BHD51-F	0.80
	⑦ Hook expansion bolt	1	See P2/79	52017	0.03
	⑧ Chain	1	Length: 450mm	80B11	0.08
	⑨ Elbow pipe 90°(M25 x 1.5)	1	Length: 400mm	51022	0.55

**Note:** 1. Accessories not in the table shall be supplied by user.

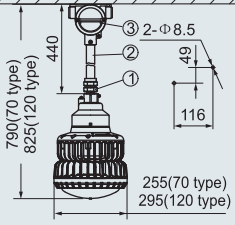
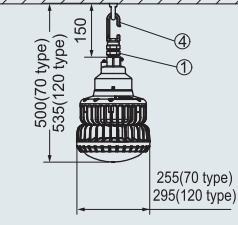
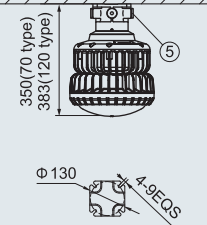
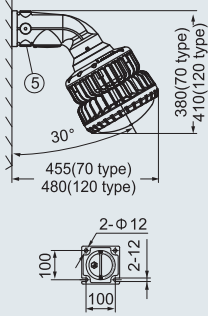
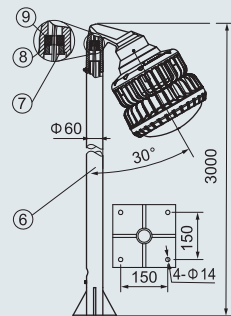

2. Pole ⑥ shall not be supplied with light fittings; if required, please specify when ordering.

### Mounting type (HRD85-70 type, HRD85-120 type) (all dimensions in mm) - subject to alteration

G: pendant pole type	D: hook type	X: ceiling type	B: wall type	L: pole type
 <p><b>Weight:</b> 7.80kg (70type) 8.80kg (120type)</p> <p><b>Accessories supplied with the light fittings:</b></p> <ol style="list-style-type: none"> <li>BGJ-III explosion-proof connector G3/4" (M)/M25 x 1.5 (F), carbon steel.</li> <li>Straight pipe(M25 x 1.5), length: 300mm.</li> <li>BHD51-F(Ex d IIC, copper-free aluminium), see P3/4.</li> </ol>	 <p><b>Weight:</b> 6.50kg (70type) 7.50kg (120type)</p> <p><b>Accessories supplied with the light fittings:</b></p> <ol style="list-style-type: none"> <li>BGJ-III explosion-proof connector G3/4" (M)/M25 x 1.5 (F), carbon steel.</li> <li>Hook (carbon steel).</li> </ol>	 <p><b>Weight:</b> 7.40kg (70type) 8.40kg (120type)</p> <p><b>Accessories supplied with the light fittings:</b></p> <ol style="list-style-type: none"> <li>4 x M25 x 1.5 Plug; Ex d cable gland (optional): DQM-II (Ex d) or DQM-III (Ex d) is recommended. Please see P7/20-27.</li> </ol>	 <p><b>Weight:</b> 9.20kg (70type) 10.20kg (120type)</p> <p><b>Accessories supplied with the light fittings:</b></p> <ol style="list-style-type: none"> <li>4 x M25 x 1.5 Plug; Ex d cable gland (optional): DQM-II (Ex d) or DQM-III (Ex d) is recommended. Please see P7/20-27.</li> </ol>	 <p><b>Weight:</b> 7.70kg (70type) 8.70kg (120type)</p> <p><b>Accessories supplied with the light fittings:</b></p> <ol style="list-style-type: none"> <li>Pole shall be provided by user.</li> <li>Locking bolt, 1 No.</li> <li>Washer, 2 Nos.</li> <li>Seal ring, 1 N</li> </ol>



### Accessories

Picture	Name	Ordering code	Weight (kg)
	LED driver 20W	85001	0.20
	LED driver 30W	85002	0.20
	LED driver 50W	85003	0.45
	LED driver 70W	85004	0.45
	LED driver 100W	85005	0.58
	LED driver 120W	85006	0.58
	LED lamp module 20W	85007	0.10
	LED lamp module 30W	85008	0.10
	LED lamp module 50W	85009	0.15
	LED lamp module 70W	85010	0.15
	LED lamp module 100W	85011	0.27
	LED lamp module 120W	85012	0.27
	30Type transparent cover with fixing-ring	85013	1.20
	70Type transparent cover with fixing-ring	85014	1.84
	120Type transparent cover with fixing-ring	85015	2.90